

PNP Silicon AF Transistors

BC 327
BC 328

- High current gain
- High collector current
- Low collector-emitter saturation voltage
- Complementary types: BC 337, BC 338 (NPN)

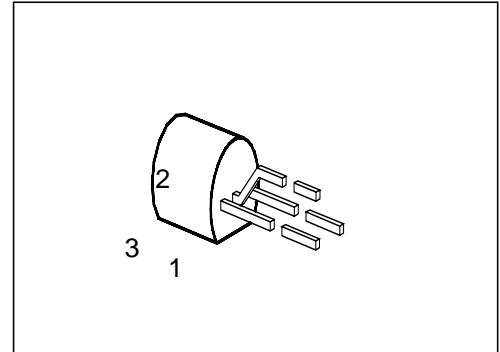

Type	Marking	Ordering Code	Pin Configuration			Package ¹⁾
			1	2	3	
BC 327	—	Q62702-C311	C	B	E	TO-92
BC 327-16		Q62702-C311-V3				
BC 327-25		Q62702-C311-V4				
BC 327-40		Q62702-C311-V2				
BC 328		Q62702-C312				
BC 328-16		Q62702-C312-V3				
BC 328-25		Q62702-C312-V4				
BC 328-40		Q62702-C312-V2				

¹⁾ For detailed information see chapter Package Outlines.

Maximum Ratings

Parameter	Symbol	Values		Unit
		BC 327	BC 328	
Collector-emitter voltage	V_{CE0}	45	25	V
Collector-base voltage	V_{CB0}	50	30	
Emitter-base voltage	V_{EB0}	5		
Collector current	I_C	800		mA
Peak collector current	I_{CM}	1		A
Base current	I_B	100		mA
Peak base current	I_{BM}	200		
Total power dissipation, $T_C = 66\text{ °C}$	P_{tot}	625		mW
Junction temperature	T_j	150		°C
Storage temperature range	T_{stg}	– 65 ... + 150		

Thermal Resistance

Junction - ambient	$R_{th\ JA}$	≤ 200	K/W
Junction - case ¹⁾	$R_{th\ JC}$	≤ 135	

¹⁾ Mounted on Al heat sink 15 mm × 25 mm × 0.5 mm.

Electrical Characteristics

at $T_A = 25\text{ °C}$, unless otherwise specified.

Parameter	Symbol	Values			Unit
		min.	typ.	max.	

DC characteristics

Collector-emitter breakdown voltage $I_C = 10\text{ mA}$	$V_{(BR)CE0}$				V
BC 327		45	–	–	
BC 328		25	–	–	
Collector-base breakdown voltage $I_C = 100\text{ }\mu\text{A}$	$V_{(BR)CB0}$				
BC 327		50	–	–	
BC 328		30	–	–	
Emitter-base breakdown voltage $I_E = 10\text{ }\mu\text{A}$	$V_{(BR)EB0}$	5	–	–	
Collector cutoff current $V_{CB} = 25\text{ V}$	I_{CB0}				nA
BC 328		–	–	100	
$V_{CB} = 45\text{ V}$					nA
BC 327		–	–	100	
$V_{CB} = 25\text{ V}, T_A = 150\text{ °C}$					μA
BC 328		–	–	10	
$V_{CB} = 45\text{ V}, T_A = 150\text{ °C}$					μA
BC 327		–	–	10	
Emitter cutoff current $V_{EB} = 4\text{ V}$	I_{EB0}	–	–	100	nA
DC current gain ¹⁾ $I_C = 100\text{ mA}; V_{CE} = 1\text{ V}$	h_{FE}				–
BC 327/16; BC 328/16		100	160	250	
BC 327/25; BC 328/25		160	250	400	
BC 327/40; BC 328/40		250	350	630	
$I_C = 300\text{ mA}; V_{CE} = 1\text{ V}$					
BC 327/16; BC 328/16		60	–	–	
BC 327/25; BC 328/25		100	–	–	
BC 327/40; BC 328/40		170	–	–	
Collector-emitter saturation voltage ¹⁾ $I_C = 500\text{ mA}; I_B = 50\text{ mA}$	V_{CEsat}	–	–	0.7	V
Base-emitter saturation voltage ¹⁾ $I_C = 500\text{ mA}; I_B = 50\text{ mA}$	V_{BEsat}	–	–	2	

¹⁾ Pulse test: $t \leq 300\text{ }\mu\text{s}$, $D \leq 2\text{ %}$.

Electrical Characteristics

at $T_A = 25\text{ }^\circ\text{C}$, unless otherwise specified.

Parameter	Symbol	Values			Unit
		min.	typ.	max.	

AC characteristics

Transition frequency $I_C = 50\text{ mA}$, $V_{CE} = 5\text{ V}$, $f = 20\text{ MHz}$	f_t	–	200	–	MHz
Output capacitance $V_{CB} = 10\text{ V}$, $f = 1\text{ MHz}$	C_{obo}	–	12	–	pF
Input capacitance $V_{EB} = 0.5\text{ V}$, $f = 1\text{ MHz}$	C_{ibo}	–	60	–	

Total power dissipation $P_{tot} = f(T_A; T_C)$

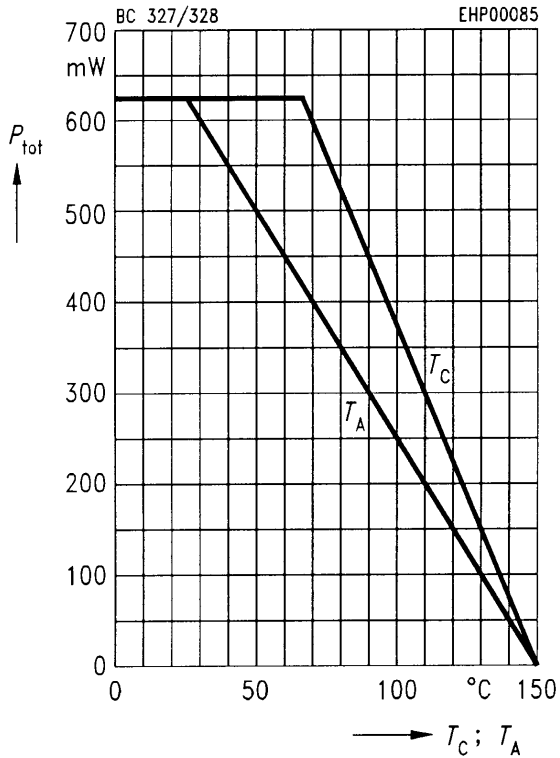

Permissible pulse load $R_{thJA} = f(t_p)$

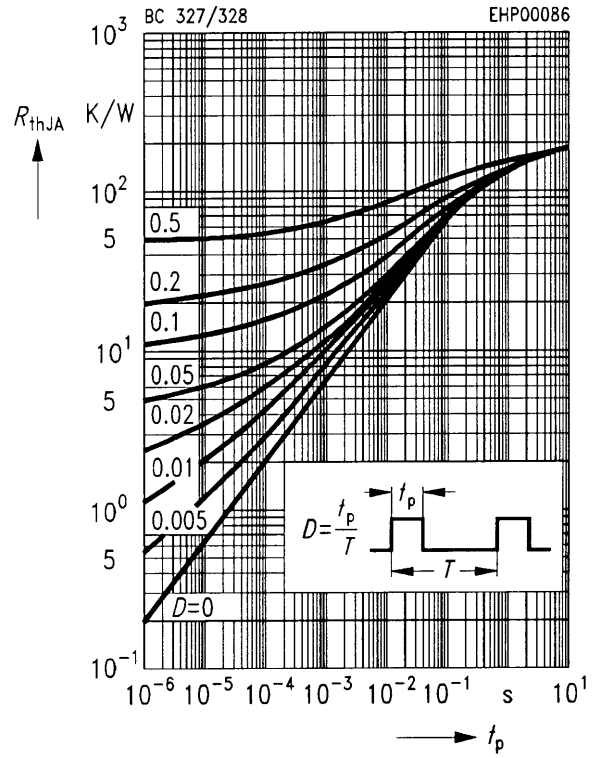

Collector current $I_C = f(V_{BE})$
 $V_{CE} = 1$ V

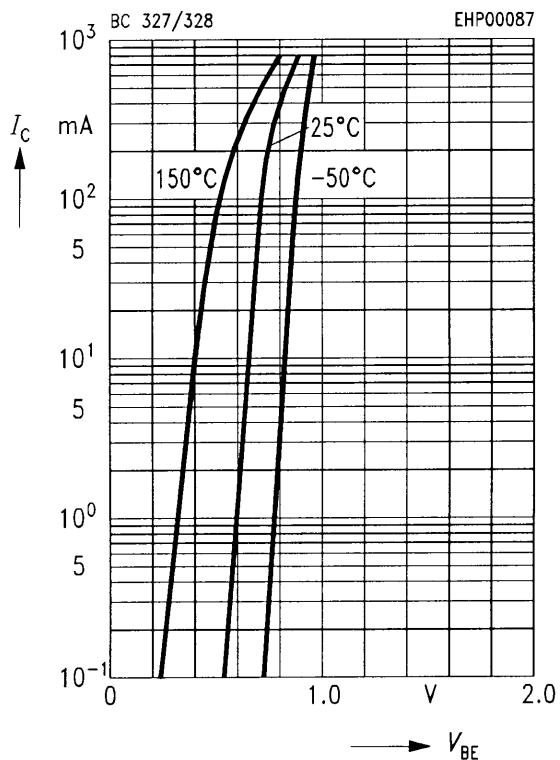

Collector cutoff current $I_{CB0} = f(T_A)$
 $V_{CB} = 45$ V

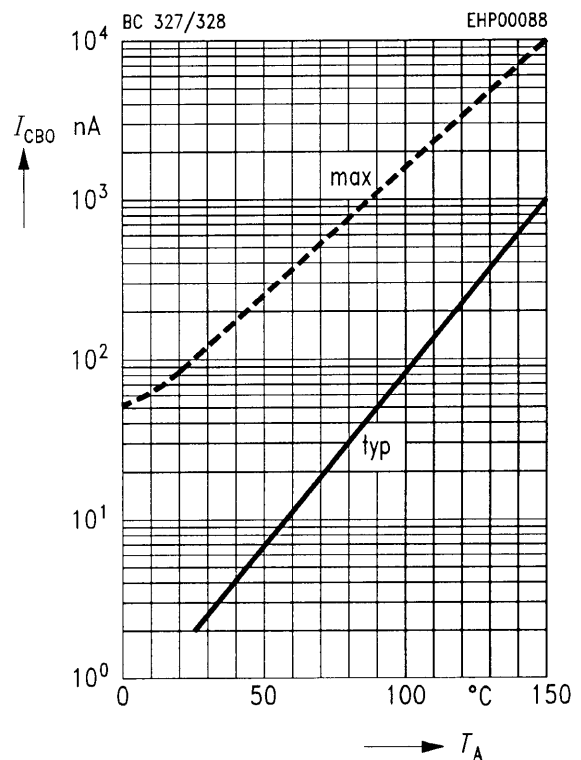

DC current gain $h_{FE} = f(I_C)$

$V_{CE} = 1\text{ V}$

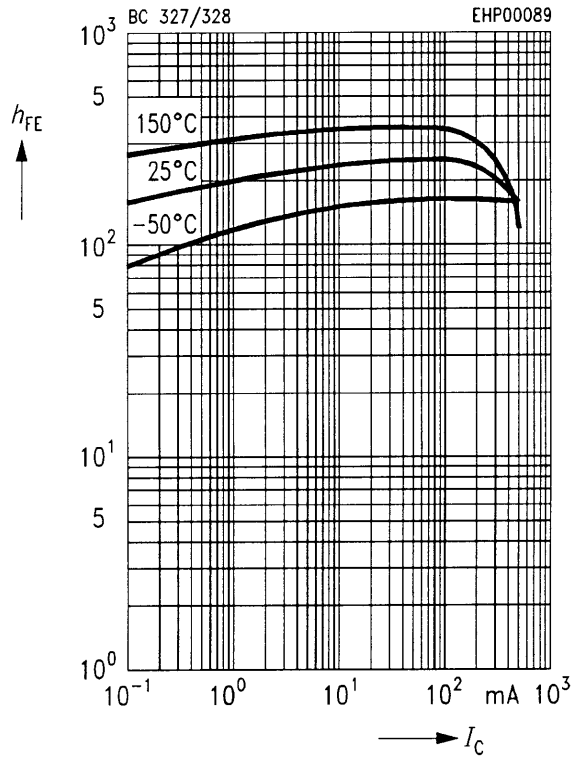

Transition frequency $f_T = f(I_C)$

$f = 20\text{ MHz}, T_A = 25\text{ °C}$

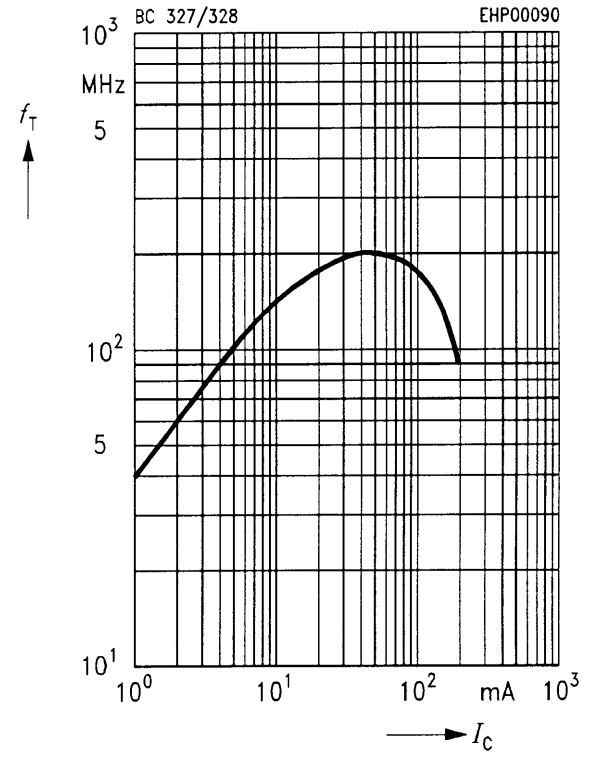

Collector-emitter saturation voltage

$V_{CEsat} = f(I_C)$

$h_{FE} = 10$

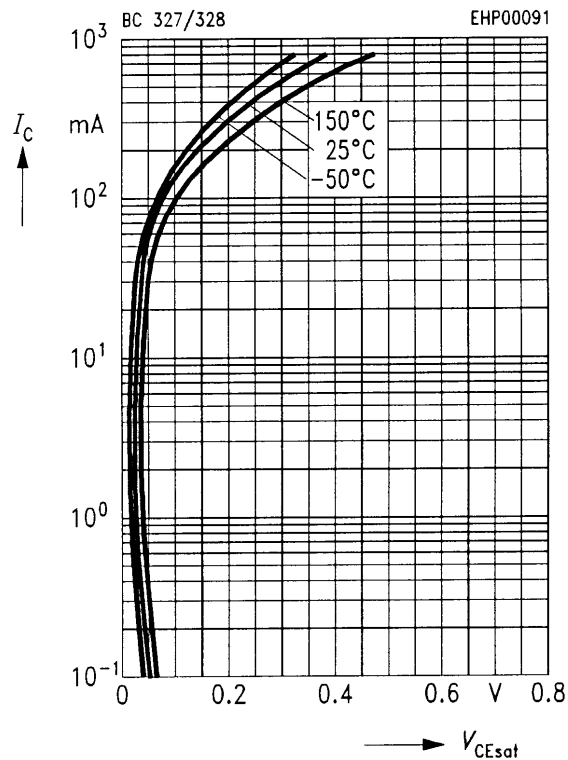

Base-emitter saturation voltage

$V_{BEsat} = f(I_C)$

$h_{FE} = 10$

