

## TO-92 Plastic-Encapsulate Transistors

### BC327/BC328 TRANSISTOR (PNP)

#### FEATURES

- Power dissipation

#### MAXIMUM RATINGS (T<sub>a</sub>=25°C unless otherwise noted)

Symbol	Parameter	Value	Unit
V <sub>CBO</sub>	Collector-Base Voltage	BC327	-50
		BC328	-30
V <sub>CEO</sub>	Collector-Emitter Voltage	BC327	-45
		BC328	-25
V <sub>EBO</sub>	Emitter-Base Voltage	-5	V
I <sub>C</sub>	Collector Current -Continuous	-800	mA
P <sub>C</sub>	Collector Power Dissipation	625	mW
T <sub>j</sub>	Junction Temperature	150	°C
T <sub>stg</sub>	Storage Temperature	-55-150	°C

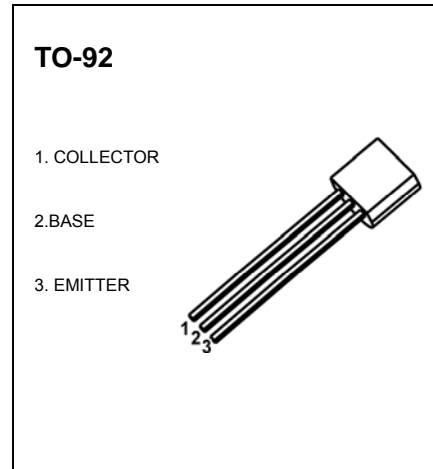

#### ELECTRICAL CHARACTERISTICS (T<sub>a</sub>=25°C unless otherwise specified)

Parameter	Symbol	Test conditions	Min	Typ	Max	Unit
Collector-base breakdown voltage	V <sub>CBO</sub>	I <sub>C</sub> = -100uA, I <sub>E</sub> =0	-50			V
			-30			
Collector-emitter breakdown voltage	V <sub>CEO</sub>	I <sub>C</sub> = -10mA, I <sub>B</sub> =0	-45			V
			-25			
Emitter-base breakdown voltage	V <sub>EBO</sub>	I <sub>E</sub> = -10uA, I <sub>C</sub> =0	-5			V
Collector cut-off current	I <sub>CBO</sub>	V <sub>CB</sub> = -45 V, I <sub>E</sub> =0 V <sub>CB</sub> = -25V, I <sub>E</sub> =0			-0.1	uA
					-0.1	
Collector cut-off current	I <sub>CEO</sub>	V <sub>CE</sub> = -40 V, I <sub>B</sub> =0 V <sub>CE</sub> = -20 V, I <sub>B</sub> =0			-0.2	uA
					-0.2	
Emitter cut-off current	I <sub>EBO</sub>	V <sub>EB</sub> = -4 V, I <sub>C</sub> =0			-0.1	uA
DC current gain	h <sub>FE(1)</sub>	V <sub>CE</sub> =-1 V, I <sub>C</sub> = -100mA	100		630	
	h <sub>FE(2)</sub>	V <sub>CE</sub> =-1 V, I <sub>C</sub> = -300mA	40			
Collector-emitter saturation voltage	V <sub>CE(sat)</sub>	I <sub>C</sub> =-500mA, I <sub>B</sub> = -50mA			-0.7	V
Base-emitter saturation voltage	V <sub>BE(sat)</sub>	I <sub>C</sub> = -500mA, I <sub>B</sub> =-50mA			-1.2	V
Base-emitter voltage	V <sub>BE</sub>	V <sub>CE</sub> =-1 V, I <sub>C</sub> = -300mA			-1.2	V
Transition frequency	f <sub>T</sub>	V <sub>CE</sub> = -5V, I <sub>C</sub> = -10mA f = 100MHz	260			MHz
Collector Output Capacitance	C <sub>ob</sub>	V <sub>CB</sub> =-10V, I <sub>E</sub> =0 f=1MHz		12		pF

#### CLASSIFICATION OF h<sub>FE</sub>

Rank	16	25	40
Range	100-250	160-400	250-630

# Typical Characteristics

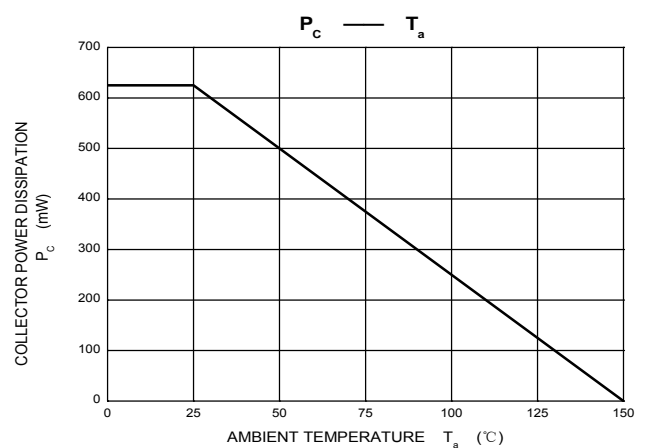
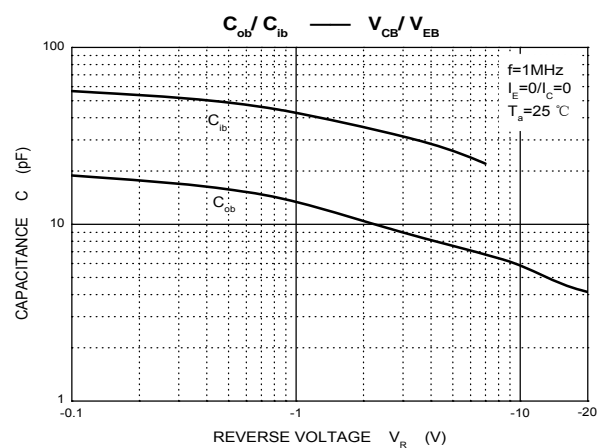
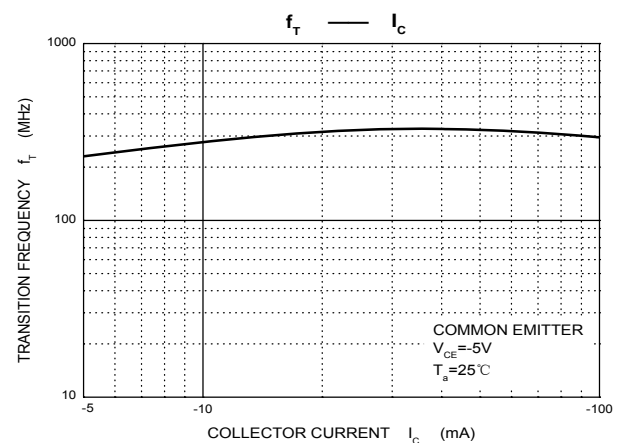
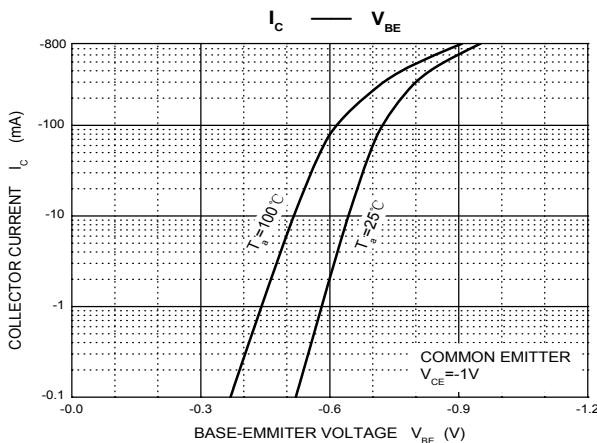
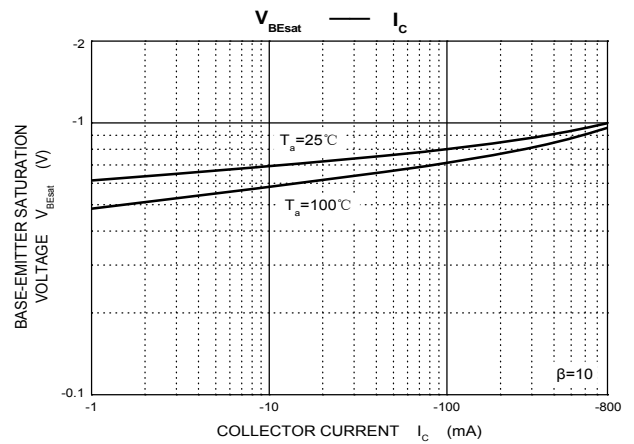
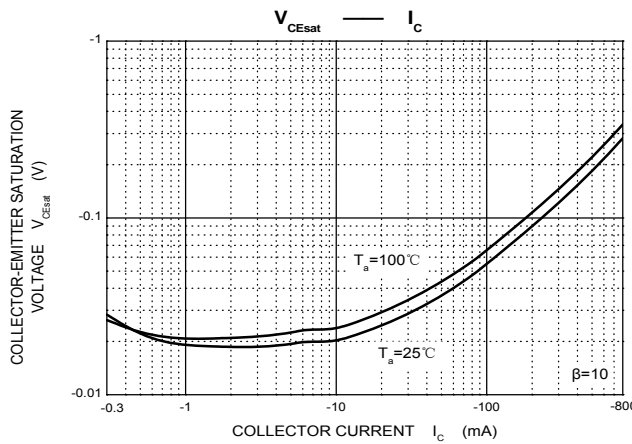
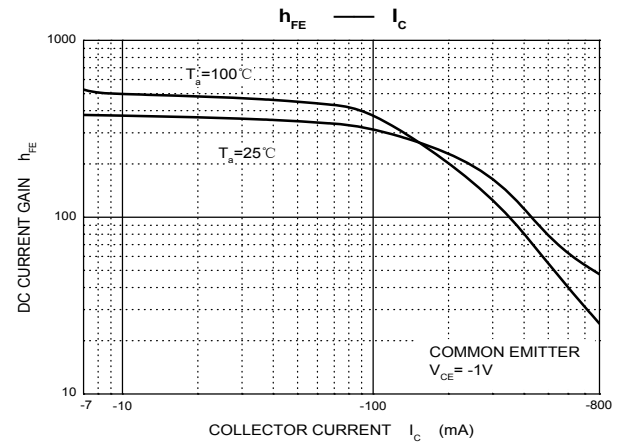
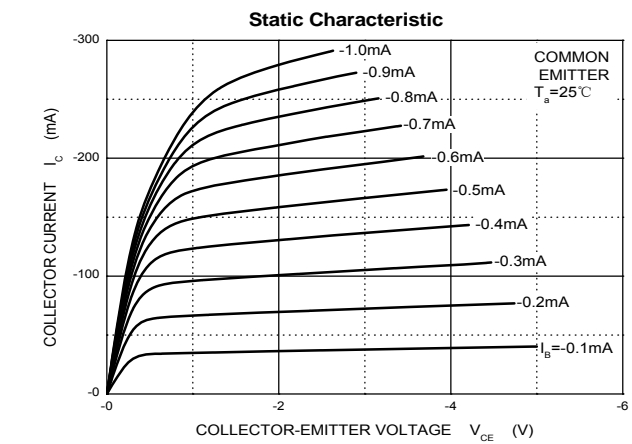

## TO-92 Package Outline Dimensions



Symbol	Dimensions In Millimeters		Dimensions In Inches	
	Min	Max	Min	Max
A	3.300	3.700	0.130	0.146
A1	1.100	1.400	0.043	0.055
b	0.380	0.550	0.015	0.022
c	0.360	0.510	0.014	0.020
D	4.300	4.700	0.169	0.185
D1	3.430		0.135	
E	4.300	4.700	0.169	0.185
e	1.270 TYP		0.050 TYP	
e1	2.440	2.640	0.096	0.104
L	14.100	14.500	0.555	0.571
Φ		1.600		0.063
h	0.000	0.380	0.000	0.015

## TO-92 Suggested Pad Layout



### Note:

1. Controlling dimension: in millimeters.
2. General tolerance:  $\pm 0.05\text{mm}$ .
3. The pad layout is for reference purposes only.

### NOTICE

JCET reserve the right to make modifications, enhancements, improvements, corrections or other changes without further notice to any product herein. JCET does not assume any liability arising out of the application or use of any product described herein.

TO-92 PACKAGE TAPING DIMENSION



Dimiensions are in millimeter								
A1	A	T	P	P0	P2	F1	F2	W
4.5	4.5	3.5	12.7	12.7	6.35	2.5	2.5	18.0
W0	W1	W2	H	H0	D0	t1	t2	ΔP
6.0	9.0	1.0 MAX.	19.0	16.0	4.0	0.4	0.2	0



Package	Box	Box Size(mm)	Carton	Carton Size(mm)
TO-92	2000 pcs	333×162×43	20,000 pcs	350×340×250