

N-Channel Enhancement Mode Field Effect Transistor

2N7000, 2N7002, NDS7002A

Description

These N-channel enhancement mode field effect transistors are produced using onsemi's proprietary, high cell density, DMOS technology. These products have been designed to minimize on-state resistance while providing rugged, reliable, and fast switching performance. They can be used in most applications requiring up to 400 mAdc and can deliver pulsed currents up to 2 A. These products are particularly suited for low-voltage, low-current applications, such as small servo motor control, power MOSFET gate drivers, and other switching applications.

Features

- High Density Cell Design for Low $R_{DS(on)}$
- Voltage Controlled Small Signal Switch
- Rugged and Reliable
- High Saturation Current Capability
- This Device is Pb-Free and Halogen Free

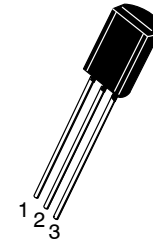
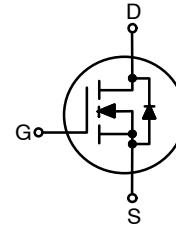

TO-92
CASE 135AN

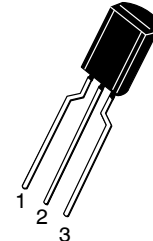

TO-92
CASE 135AR

MARKING DIAGRAM

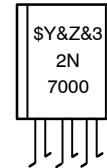

- \$Y = Logo
- &Z = Assembly Plant Code
- &3 = Date Code
- 2N7000 = Specific Device Code

MARKING DIAGRAM

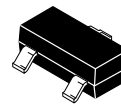

SOT-23
CASE 318-08

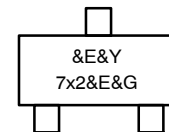

- &E = Designates Space
- &Y = Binary Calendar Year Coding Scheme
- 7x2 = Specific Device Code
x= 0, 1
- &G = Date Code

ORDERING INFORMATION

See detailed ordering and shipping information on page 7 of this data sheet.

2N7000, 2N7002, NDS7002A

ABSOLUTE MAXIMUM RATINGS Values are at $T_C = 25^\circ\text{C}$ unless otherwise noted.

| Symbol | Parameter | Value | | | Unit |
|----------------|---|------------|--------|------------|----------------------|
| | | 2N7000 | 2N7002 | NDS7002A | |
| V_{DSS} | Drain-to-Source Voltage | 60 | | | V |
| V_{DGR} | Drain-Gate Voltage ($R_{GS} \leq 1 \text{ MW}$) | 60 | | | V |
| V_{GSS} | Gate-Source Voltage - Continuous | ± 20 | | | V |
| | Gate-Source Voltage - Non Repetitive ($t_p < 50 \text{ ms}$) | ± 40 | | | |
| I_D | Maximum Drain Current - Continuous | 200 | 115 | 280 | mA |
| | Maximum Drain Current - Pulsed | 500 | 800 | 1500 | |
| P_D | Maximum Power Dissipation Derated above 25°C | 400 | 200 | 300 | mW |
| | | 3.2 | 1.6 | 2.4 | mW/ $^\circ\text{C}$ |
| T_J, T_{STG} | Operating and Storage Temperature Range | -55 to 150 | | -65 to 150 | $^\circ\text{C}$ |
| T_L | Maximum Lead Temperature for Soldering Purposes, 1/16-inch from Case for 10 s | 300 | | | $^\circ\text{C}$ |

Stresses exceeding those listed in the Maximum Ratings table may damage the device. If any of these limits are exceeded, device functionality should not be assumed, damage may occur and reliability may be affected.

THERMAL CHARACTERISTICS Values are at $T_C = 25^\circ\text{C}$ unless otherwise noted.

| Symbol | Parameter | Value | | | Unit |
|-----------------|---|--------|--------|----------|---------------------------|
| | | 2N7000 | 2N7002 | NDS7002A | |
| $R_{\theta JA}$ | Thermal Resistance, Junction to Ambient | 312.5 | 625 | 417 | $^\circ\text{C}/\text{W}$ |

ELECTRICAL CHARACTERISTICS

Values are at $T_C = 25^\circ\text{C}$ unless otherwise noted.

| Symbol | Parameter | Conditions | Type | Min. | Typ. | Max. | Unit |
|--------|-----------|------------|------|------|------|------|------|
|--------|-----------|------------|------|------|------|------|------|

OFF CHARACTERISTICS

| | | | | | | | |
|------------|---------------------------------|--|--------------------|----|---|------|---------------|
| BV_{DSS} | Drain-Source Breakdown Voltage | $V_{GS} = 0 \text{ V}, I_D = 10 \mu\text{A}$ | All | 60 | - | - | V |
| I_{DSS} | Zero Gate Voltage Drain Current | $V_{DS} = 48 \text{ V}, V_{GS} = 0 \text{ V}$ | 2N7000 | - | - | 1 | μA |
| | | $V_{DS} = 48 \text{ V}, V_{GS} = 0 \text{ V}, T_C = 125^\circ\text{C}$ | | - | - | 1 | mA |
| | | $V_{DS} = 60 \text{ V}, V_{GS} = 0 \text{ V}$ | 2N7002 NDS7002A | - | - | 1 | μA |
| | | $V_{DS} = 60 \text{ V}, V_{GS} = 0 \text{ V}, T_C = 125^\circ\text{C}$ | | - | - | 0.5 | mA |
| I_{GSSF} | Gate - Body Leakage, Forward | $V_{GS} = 15 \text{ V}, V_{DS} = 0 \text{ V}$ | 2N7000 | - | - | 10 | nA |
| | | $V_{GS} = 20 \text{ V}, V_{DS} = 0 \text{ V}$ | 2N7002 NDS7002A | - | - | 100 | |
| I_{GSSR} | Gate - Body Leakage, Reverse | $V_{GS} = -15 \text{ V}, V_{DS} = 0 \text{ V}$ | 2N7000 | - | - | -10 | nA |
| | | $V_{GS} = -20 \text{ V}, V_{DS} = 0 \text{ V}$ | 2N7002 NDS7002A | - | - | -100 | |

ON CHARACTERISTICS

| | | | | | | | |
|--------------|------------------------|--|--------------------|-----|-----|-----|---|
| $V_{GS(th)}$ | Gate Threshold Voltage | $V_{DS} = V_{GS}, I_D = 1 \text{ mA}$ | 2N7000 | 0.8 | 2.1 | 3 | V |
| | | $V_{DS} = V_{GS}, I_D = 250 \mu\text{A}$ | 2N7002 NDS7002A | 1 | 2.1 | 2.5 | |

2N7000, 2N7002, NDS7002A

ELECTRICAL CHARACTERISTICS (continued)

Values are at $T_C = 25^\circ\text{C}$ unless otherwise noted.

| Symbol | Parameter | Conditions | Type | Min. | Typ. | Max. | Unit |
|--|-----------------------------------|--|----------|------|------|------|----------|
| ON CHARACTERISTICS | | | | | | | |
| $R_{DS(on)}$ | Static Drain-Source On-Resistance | $V_{GS} = 10\text{ V}, I_D = 500\text{ mA}$ | 2N7000 | - | 1.2 | 5 | Ω |
| | | $V_{GS} = 10\text{ V}, I_D = 500\text{ mA}, T_C = 125^\circ\text{C}$ | | - | 1.9 | 9 | |
| | | $V_{GS} = 4.5\text{ V}, I_D = 75\text{ mA}$ | | - | 1.8 | 5.3 | |
| | | $V_{GS} = 10\text{ V}, I_D = 500\text{ mA}$ | 2N7002 | - | 1.2 | 7.5 | |
| | | $V_{GS} = 10\text{ V}, I_D = 500\text{ mA}, T_C = 100^\circ\text{C}$ | | - | 1.7 | 13.5 | |
| | | $V_{GS} = 5\text{ V}, I_D = 50\text{ mA}$ | | - | 1.7 | 7.5 | |
| | | $V_{GS} = 5\text{ V}, I_D = 50\text{ mA}, T_C = 100^\circ\text{C}$ | | - | 2.4 | 13.5 | |
| | | $V_{GS} = 10\text{ V}, I_D = 500\text{ mA}$ | NDS7002A | - | 1.2 | 2 | |
| | | $V_{GS} = 10\text{ V}, I_D = 500\text{ mA}, T_C = 125^\circ\text{C}$ | | - | 2 | 3.5 | |
| | | $V_{GS} = 5\text{ V}, I_D = 50\text{ mA}$ | | - | 1.7 | 3 | |
| $V_{GS} = 5\text{ V}, I_D = 50\text{ mA}, T_C = 125^\circ\text{C}$ | - | 2.8 | | 5 | | | |
| $V_{DS(on)}$ | Drain-Source On-Voltage | $V_{GS} = 10\text{ V}, I_D = 500\text{ mA}$ | 2N7000 | - | 0.6 | 2.5 | V |
| | | $V_{GS} = 4.5\text{ V}, I_D = 75\text{ mA}$ | | - | 0.14 | 0.4 | |
| | | $V_{GS} = 10\text{ V}, I_D = 500\text{ mA}$ | 2N7002 | - | 0.6 | 3.75 | |
| | | $V_{GS} = 5.0\text{ V}, I_D = 50\text{ mA}$ | | - | 0.09 | 1.5 | |
| | | $V_{GS} = 10\text{ V}, I_D = 500\text{ mA}$ | NDS7002A | - | 0.6 | 1 | |
| | | $V_{GS} = 5.0\text{ V}, I_D = 50\text{ mA}$ | | - | 0.09 | 0.15 | |
| $I_{D(on)}$ | On-State Drain Current | $V_{GS} = 4.5\text{ V}, V_{DS} = 10\text{ V}$ | 2N7000 | 75 | 600 | - | mA |
| | | $V_{GS} = 10\text{ V}, V_{DS} \geq 2 V_{DS(on)}$ | 2N7002 | 500 | 2700 | - | |
| | | $V_{GS} = 10\text{ V}, V_{DS} \geq 2 V_{DS(on)}$ | NDS7002A | 500 | 2700 | - | |
| g_{FS} | Forward Transconductance | $V_{DS} = 10\text{ V}, I_D = 200\text{ mA}$ | 2N7000 | 100 | 320 | - | mS |
| | | $V_{DS} \geq 2 V_{DS(on)}, I_D = 200\text{ mA}$ | 2N7002 | 80 | 320 | - | |
| | | $V_{DS} \geq 2 V_{DS(on)}, I_D = 200\text{ mA}$ | NDS7002A | 80 | 320 | - | |

DYNAMIC CHARACTERISTICS

| | | | | | | | |
|-----------|------------------------------|--|--------------------|---|----|----|----|
| C_{iss} | Input Capacitance | $V_{DS} = 25\text{ V}, V_{GS} = 0\text{ V}, f = 1.0\text{ MHz}$ | All | - | 20 | 50 | pF |
| C_{oss} | Output Capacitance | | All | - | 11 | 25 | |
| C_{rss} | Reverse Transfer Capacitance | | All | - | 4 | 5 | |
| t_{on} | Turn-On Time | $V_{DD} = 15\text{ V}, R_L = 25\ \Omega, I_D = 500\text{ mA}, V_{GS} = 10\text{ V}, R_{GEN} = 25\ \Omega$ | 2N7000 | - | - | 10 | ns |
| | | $V_{DD} = 30\text{ V}, R_L = 150\ \Omega, I_D = 200\text{ mA}, V_{GS} = 10\text{ V}, R_{GEN} = 25\ \Omega$ | 2N7002 NDS7002A | - | - | 20 | |
| t_{off} | Turn-Off Time | $V_{DD} = 15\text{ V}, R_L = 25\ \Omega, I_D = 500\text{ mA}, V_{GS} = 10\text{ V}, R_{GEN} = 25\ \Omega$ | 2N7000 | - | - | 10 | ns |
| | | $V_{DD} = 30\text{ V}, R_L = 150\ \Omega, I_D = 200\text{ mA}, V_{GS} = 10\text{ V}, R_{GEN} = 25\ \Omega$ | 2N7002 NDS7002A | - | - | 20 | |

2N7000, 2N7002, NDS7002A

ELECTRICAL CHARACTERISTICS (continued)

Values are at $T_C = 25^\circ\text{C}$ unless otherwise noted.

| Symbol | Parameter | Conditions | Type | Min. | Typ. | Max. | Unit |
|----------|---|--|----------|------|------|------|------|
| I_S | Maximum Continuous Drain-Source Diode Forward Current | | 2N7002 | - | - | 115 | mA |
| | | | NDS7002A | - | - | 280 | |
| I_{SM} | Maximum Pulsed Drain-Source Diode Forward Current | | 2N7002 | - | - | 0.8 | A |
| | | | NDS7002A | - | - | 1.5 | |
| V_{SD} | Drain-Source Diode Forward Voltage | $V_{GS} = 0\text{ V}, I_S = 115\text{ mA}$ (Note 1) | 2N7002 | - | 0.88 | 1.5 | V |
| | | $V_{GS} = 0\text{ V}, I_S = 400\text{ mA}$ (Note 1) | NDS7002A | - | 0.88 | 1.2 | |

Product parametric performance is indicated in the Electrical Characteristics for the listed test conditions, unless otherwise noted. Product performance may not be indicated by the Electrical Characteristics if operated under different conditions.

1. Pulse test: Pulse Width $\leq 300\ \mu\text{s}$, Duty Cycle $\leq 2\%$

TYPICAL PERFORMANCE CHARACTERISTICS

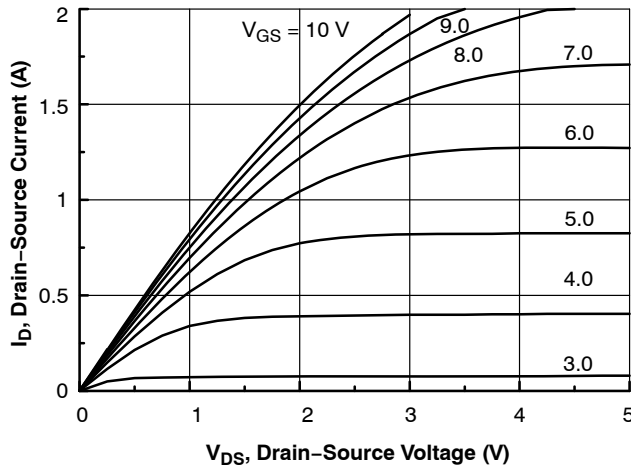

Figure 1. On-Region Characteristics

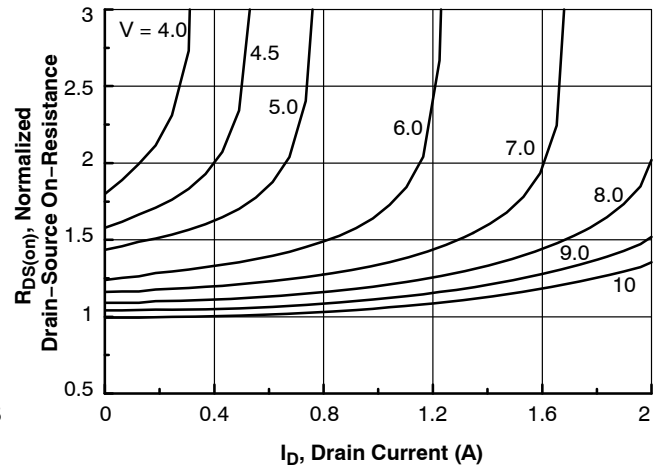

Figure 2. On-Resistance Variation with Gate Voltage and Drain Current

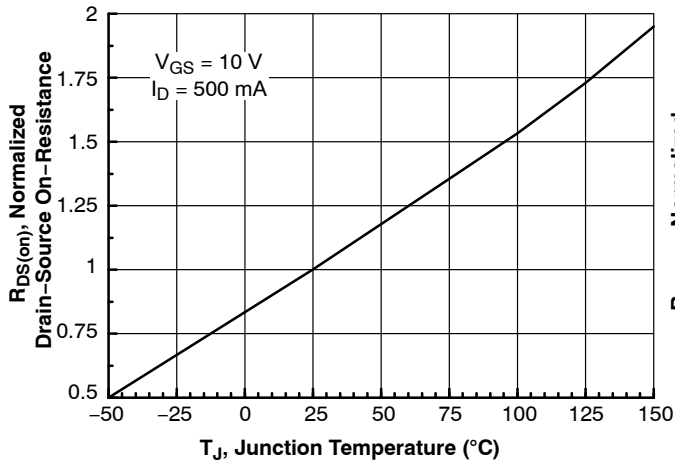

Figure 3. On-Resistance Variation with Temperature

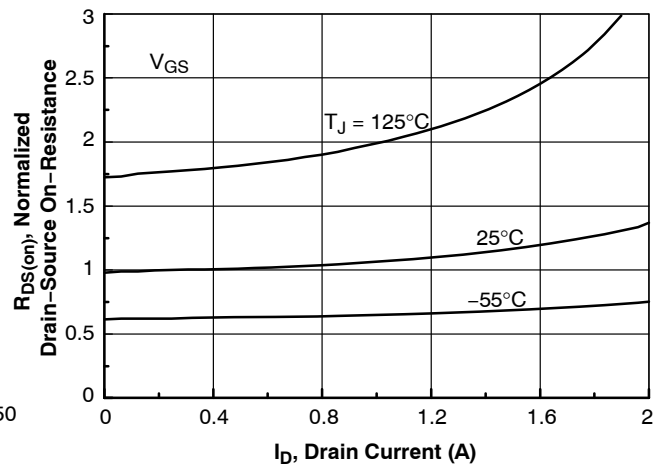

Figure 4. On-Resistance Variation with Drain Current and Temperature

TYPICAL PERFORMANCE CHARACTERISTICS (Continued)

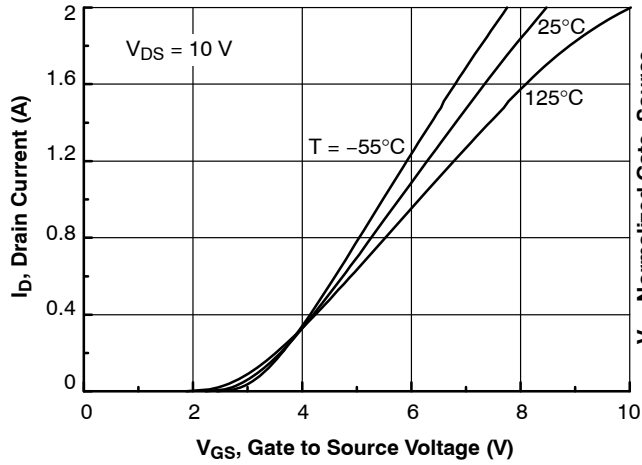

Figure 5. Transfer Characteristics

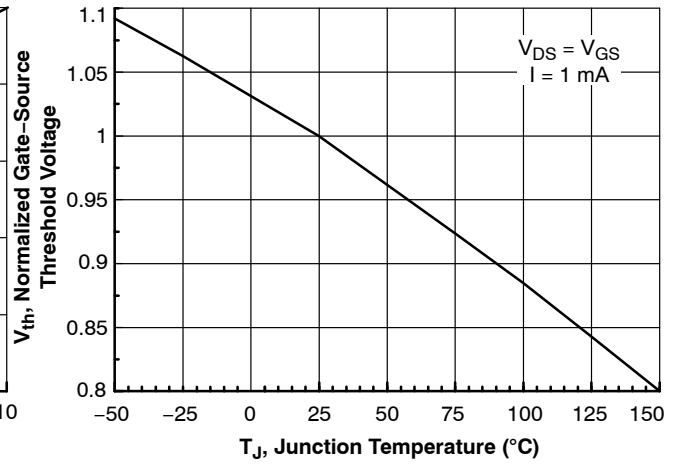

Figure 6. Gate Threshold Variation with Temperature

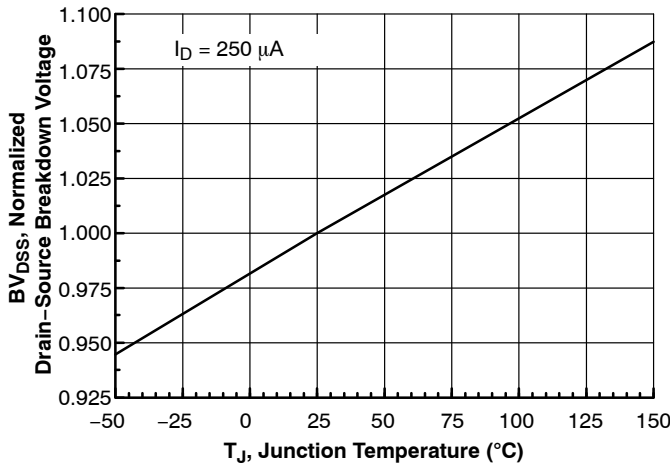

Figure 7. Breakdown Voltage Variation with Temperature

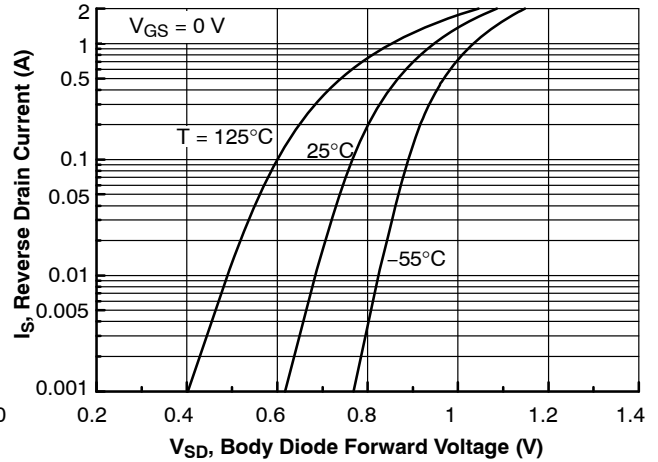

Figure 8. Body Diode Forward Voltage Variation with Temperature

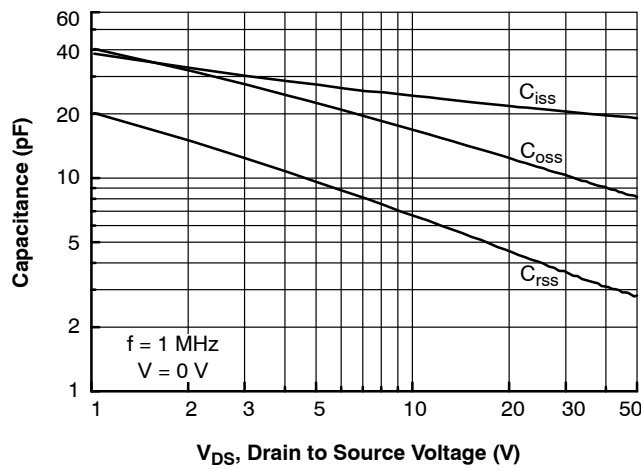

Figure 9. Capacitance Characteristics

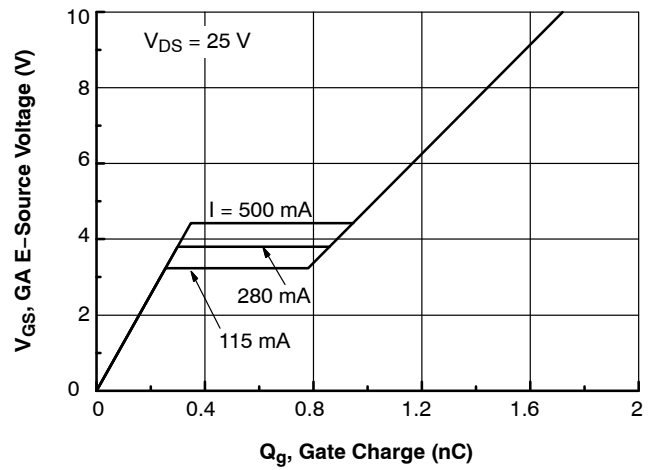

Figure 10. Gate Charge Characteristics

2N7000, 2N7002, NDS7002A

TYPICAL PERFORMANCE CHARACTERISTICS (Continued)

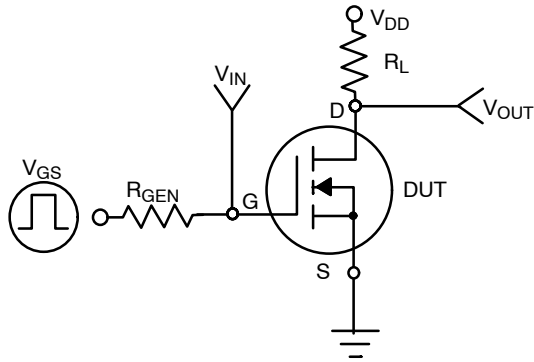

Figure 11. Switching Test Circuit



Figure 12. Switching Waveforms

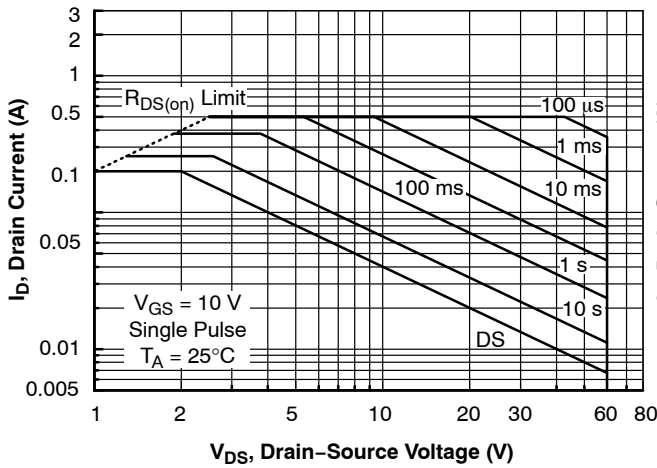

Figure 13. 2N7000 Maximum Safe Operating Area

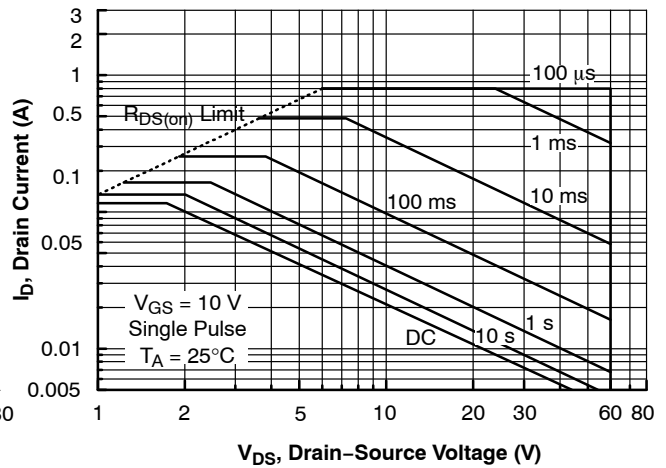

Figure 14. 2N7002 Maximum Safe Operating Area

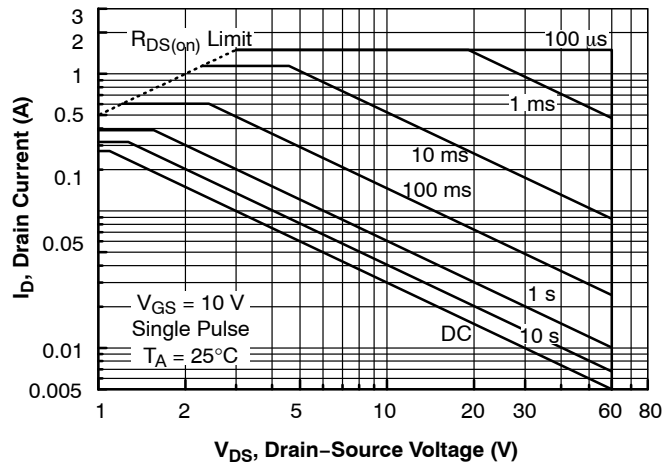

Figure 15. NDS7000A Maximum Safe Operating Area

2N7000, 2N7002, NDS7002A

TYPICAL PERFORMANCE CHARACTERISTICS (Continued)

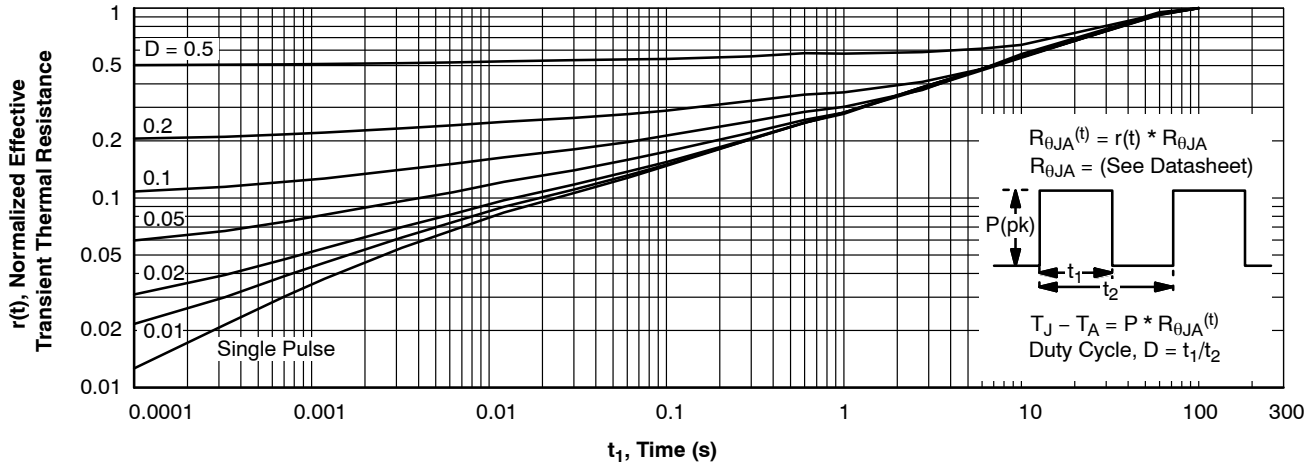

Figure 16. TO-92, 2N7000 Transient Thermal Response Curve

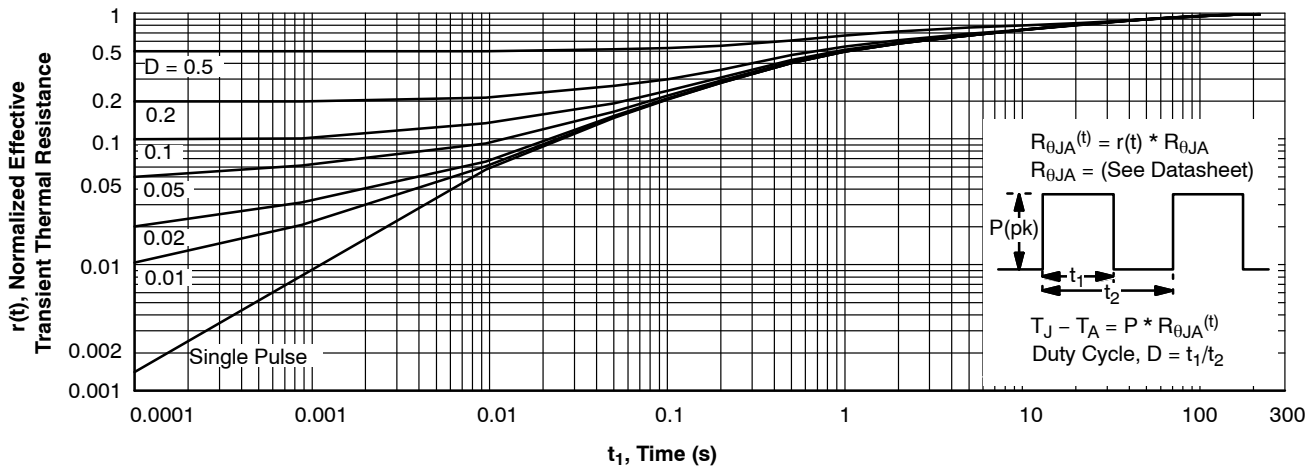

Figure 17. SOT-23, 2N7002 / NDS7002A Transient Thermal Response Curve

ORDERING INFORMATION

| Part Number | Marking | Package | Packing Method† | Min Order Qty / Immediate Pack Qty |
|-------------|---------|------------------------|-----------------|------------------------------------|
| 2N7000 | 2N7000 | TO-92 3L (Pb-Free) | Bulk | 10000 / 1000 |
| 2N7000-D74Z | | | Ammo | 2000 / 2000 |
| 2N7000-D75Z | | | Tape and Reel | 2000 / 2000 |
| 2N7000-D26Z | | | | 2000 / 2000 |
| 2N7002 | 702 | SOT-23 3L (Pb-Free) | Tape and Reel | 3000 / 3000 |
| NDS7002A | 712 | | | 3000 / 3000 |

†For information on tape and reel specifications, including part orientation and tape sizes, please refer to our Tape and Reel Packaging Specifications Brochure, BRD8011/D.

MECHANICAL CASE OUTLINE
PACKAGE DIMENSIONS

TO-92 3 4.825x4.76
CASE 135AN
ISSUE O

DATE 31 JUL 2016

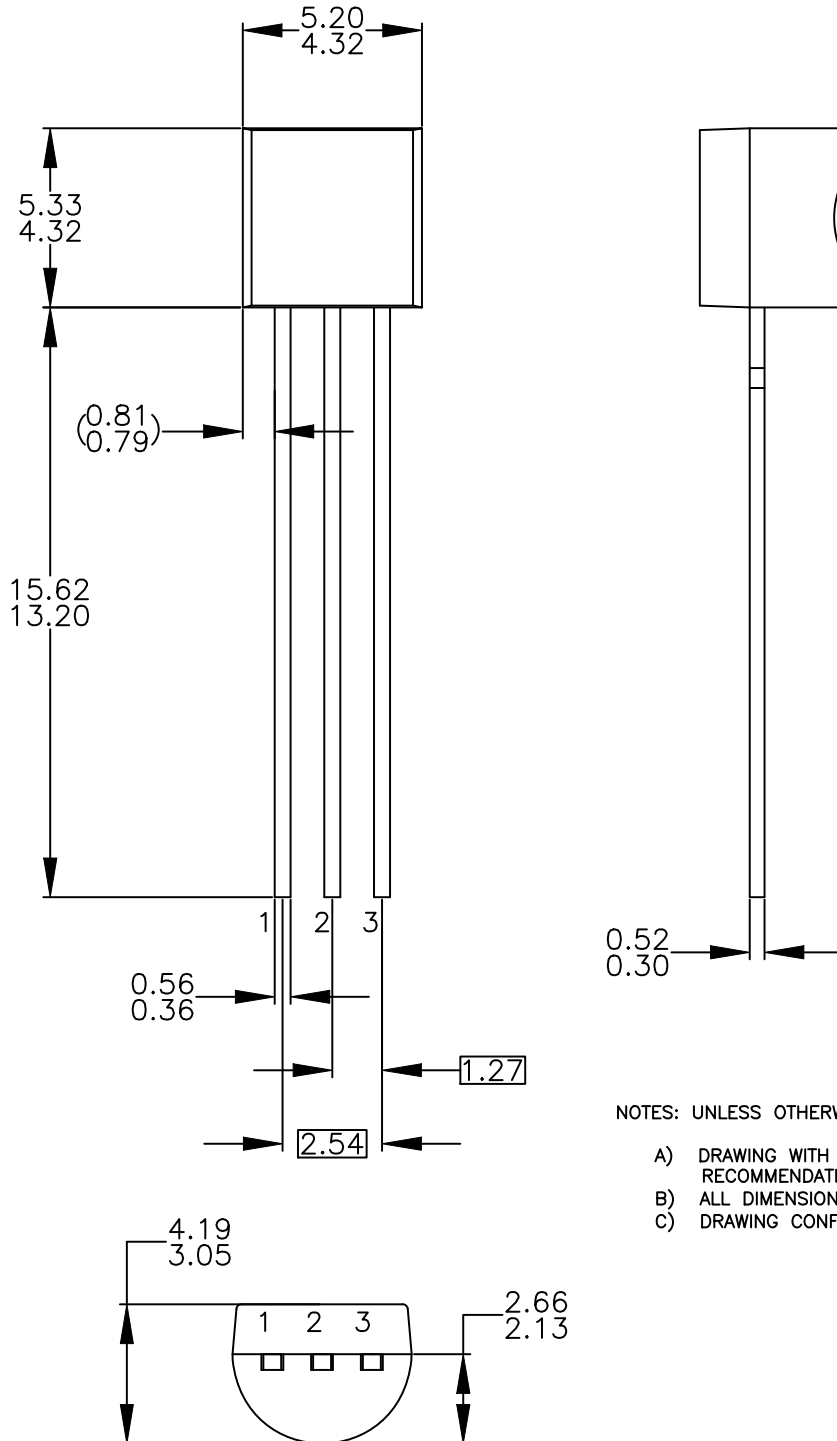

NOTES: UNLESS OTHERWISE SPECIFIED

- A) DRAWING WITH REFERENCE TO JEDEC TO-92 RECOMMENDATIONS.
- B) ALL DIMENSIONS ARE IN MILLIMETERS.
- C) DRAWING CONFORMS TO ASME Y14.5M-2009.

| | | |
|-------------------------|---------------------------|--|
| DOCUMENT NUMBER: | 98AON13880G | Electronic versions are uncontrolled except when accessed directly from the Document Repository. Printed versions are uncontrolled except when stamped "CONTROLLED COPY" in red. |
| DESCRIPTION: | TO-92 3 4.825X4.76 | PAGE 1 OF 1 |

ON Semiconductor and **ON** are trademarks of Semiconductor Components Industries, LLC dba ON Semiconductor or its subsidiaries in the United States and/or other countries. ON Semiconductor reserves the right to make changes without further notice to any products herein. ON Semiconductor makes no warranty, representation or guarantee regarding the suitability of its products for any particular purpose, nor does ON Semiconductor assume any liability arising out of the application or use of any product or circuit, and specifically disclaims any and all liability, including without limitation special, consequential or incidental damages. ON Semiconductor does not convey any license under its patent rights nor the rights of others.

TO-92 3 4.83x4.76 LEADFORMED
CASE 135AR
ISSUE O

DATE 30 SEP 2016

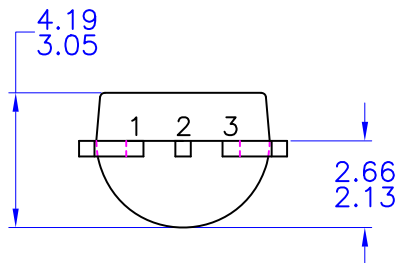
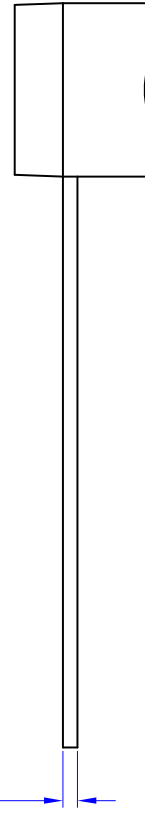
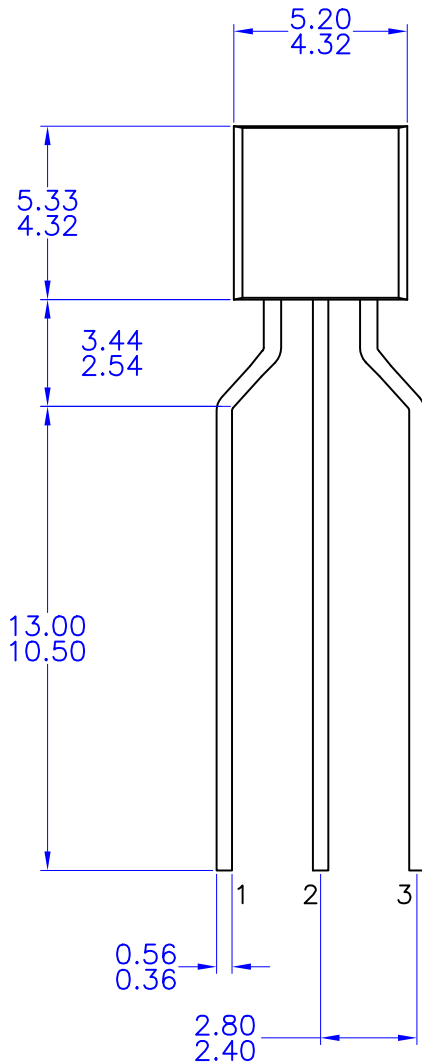

NOTES: UNLESS OTHERWISE SPECIFIED

- A) DRAWING WITH REFERENCE TO JEDEC TO-92 RECOMMENDATIONS.
- B) ALL DIMENSIONS ARE IN MILLIMETERS.
- C) DRAWING CONFORMS TO ASME Y14.5M-1994

| | | |
|-------------------------|-------------------------------------|--|
| DOCUMENT NUMBER: | 98AON13879G | Electronic versions are uncontrolled except when accessed directly from the Document Repository. Printed versions are uncontrolled except when stamped "CONTROLLED COPY" in red. |
| DESCRIPTION: | TO-92 3 4.83X4.76 LEADFORMED | PAGE 1 OF 1 |

ON Semiconductor and **ON** are trademarks of Semiconductor Components Industries, LLC dba ON Semiconductor or its subsidiaries in the United States and/or other countries. ON Semiconductor reserves the right to make changes without further notice to any products herein. ON Semiconductor makes no warranty, representation or guarantee regarding the suitability of its products for any particular purpose, nor does ON Semiconductor assume any liability arising out of the application or use of any product or circuit, and specifically disclaims any and all liability, including without limitation special, consequential or incidental damages. ON Semiconductor does not convey any license under its patent rights nor the rights of others.

MECHANICAL CASE OUTLINE

PACKAGE DIMENSIONS

ON Semiconductor®



SOT-23 (TO-236)
CASE 318-08
ISSUE AS

DATE 30 JAN 2018

SCALE 4:1



NOTES:

1. DIMENSIONING AND TOLERANCING PER ASME Y14.5M, 1994.
2. CONTROLLING DIMENSION: MILLIMETERS.
3. MAXIMUM LEAD THICKNESS INCLUDES LEAD FINISH. MINIMUM LEAD THICKNESS IS THE MINIMUM THICKNESS OF THE BASE MATERIAL.
4. DIMENSIONS D AND E DO NOT INCLUDE MOLD FLASH, PROTRUSIONS, OR GATE BURRS.

| DIM | MILLIMETERS | | | INCHES | | |
|-----|-------------|------|------|--------|-------|-------|
| | MIN | NOM | MAX | MIN | NOM | MAX |
| A | 0.89 | 1.00 | 1.11 | 0.035 | 0.039 | 0.044 |
| A1 | 0.01 | 0.06 | 0.10 | 0.000 | 0.002 | 0.004 |
| b | 0.37 | 0.44 | 0.50 | 0.015 | 0.017 | 0.020 |
| c | 0.08 | 0.14 | 0.20 | 0.003 | 0.006 | 0.008 |
| D | 2.80 | 2.90 | 3.04 | 0.110 | 0.114 | 0.120 |
| E | 1.20 | 1.30 | 1.40 | 0.047 | 0.051 | 0.055 |
| e | 1.78 | 1.90 | 2.04 | 0.070 | 0.075 | 0.080 |
| L | 0.30 | 0.43 | 0.55 | 0.012 | 0.017 | 0.022 |
| L1 | 0.35 | 0.54 | 0.69 | 0.014 | 0.021 | 0.027 |
| HE | 2.10 | 2.40 | 2.64 | 0.083 | 0.094 | 0.104 |
| T | 0° | --- | 10° | 0° | --- | 10° |

RECOMMENDED SOLDERING FOOTPRINT



GENERIC MARKING DIAGRAM*



XXX = Specific Device Code
M = Date Code
▪ = Pb-Free Package

*This information is generic. Please refer to device data sheet for actual part marking. Pb-Free indicator, "G" or microdot "▪", may or may not be present.

STYLE 1 THRU 5:
CANCELLED

STYLE 6:
PIN 1. BASE
2. EMITTER
3. COLLECTOR

STYLE 7:
PIN 1. EMITTER
2. BASE
3. COLLECTOR

STYLE 8:
PIN 1. ANODE
2. NO CONNECTION
3. CATHODE

STYLE 9:
PIN 1. ANODE
2. ANODE
3. CATHODE

STYLE 10:
PIN 1. DRAIN
2. SOURCE
3. GATE

STYLE 11:
PIN 1. ANODE
2. CATHODE
3. CATHODE-ANODE

STYLE 12:
PIN 1. CATHODE
2. CATHODE
3. ANODE

STYLE 13:
PIN 1. SOURCE
2. DRAIN
3. GATE

STYLE 14:
PIN 1. CATHODE
2. GATE
3. ANODE

STYLE 15:
PIN 1. GATE
2. CATHODE
3. ANODE

STYLE 16:
PIN 1. ANODE
2. CATHODE
3. CATHODE

STYLE 17:
PIN 1. NO CONNECTION
2. ANODE
3. CATHODE

STYLE 18:
PIN 1. NO CONNECTION
2. CATHODE
3. ANODE

STYLE 19:
PIN 1. CATHODE
2. ANODE
3. CATHODE-ANODE

STYLE 20:
PIN 1. CATHODE
2. ANODE
3. GATE

STYLE 21:
PIN 1. GATE
2. SOURCE
3. DRAIN

STYLE 22:
PIN 1. RETURN
2. OUTPUT
3. INPUT

STYLE 23:
PIN 1. ANODE
2. ANODE
3. CATHODE

STYLE 24:
PIN 1. GATE
2. DRAIN
3. SOURCE

STYLE 25:
PIN 1. ANODE
2. CATHODE
3. GATE

STYLE 26:
PIN 1. CATHODE
2. ANODE
3. NO CONNECTION

STYLE 27:
PIN 1. CATHODE
2. CATHODE
3. CATHODE

STYLE 28:
PIN 1. ANODE
2. ANODE
3. ANODE

| | | |
|-------------------------|------------------------|--|
| DOCUMENT NUMBER: | 98ASB42226B | Electronic versions are uncontrolled except when accessed directly from the Document Repository. Printed versions are uncontrolled except when stamped "CONTROLLED COPY" in red. |
| DESCRIPTION: | SOT-23 (TO-236) | PAGE 1 OF 1 |

ON Semiconductor and ON are trademarks of Semiconductor Components Industries, LLC dba ON Semiconductor or its subsidiaries in the United States and/or other countries. ON Semiconductor reserves the right to make changes without further notice to any products herein. ON Semiconductor makes no warranty, representation or guarantee regarding the suitability of its products for any particular purpose, nor does ON Semiconductor assume any liability arising out of the application or use of any product or circuit, and specifically disclaims any and all liability, including without limitation special, consequential or incidental damages. ON Semiconductor does not convey any license under its patent rights nor the rights of others.

onsemi, **Onsemi**, and other names, marks, and brands are registered and/or common law trademarks of Semiconductor Components Industries, LLC dba "**onsemi**" or its affiliates and/or subsidiaries in the United States and/or other countries. **onsemi** owns the rights to a number of patents, trademarks, copyrights, trade secrets, and other intellectual property. A listing of **onsemi**'s product/patent coverage may be accessed at www.onsemi.com/site/pdf/Patent-Marking.pdf. **onsemi** reserves the right to make changes at any time to any products or information herein, without notice. The information herein is provided "as-is" and **onsemi** makes no warranty, representation or guarantee regarding the accuracy of the information, product features, availability, functionality, or suitability of its products for any particular purpose, nor does **onsemi** assume any liability arising out of the application or use of any product or circuit, and specifically disclaims any and all liability, including without limitation special, consequential or incidental damages. Buyer is responsible for its products and applications using **onsemi** products, including compliance with all laws, regulations and safety requirements or standards, regardless of any support or applications information provided by **onsemi**. "Typical" parameters which may be provided in **onsemi** data sheets and/or specifications can and do vary in different applications and actual performance may vary over time. All operating parameters, including "Typicals" must be validated for each customer application by customer's technical experts. **onsemi** does not convey any license under any of its intellectual property rights nor the rights of others. **onsemi** products are not designed, intended, or authorized for use as a critical component in life support systems or any FDA Class 3 medical devices or medical devices with a same or similar classification in a foreign jurisdiction or any devices intended for implantation in the human body. Should Buyer purchase or use **onsemi** products for any such unintended or unauthorized application, Buyer shall indemnify and hold **onsemi** and its officers, employees, subsidiaries, affiliates, and distributors harmless against all claims, costs, damages, and expenses, and reasonable attorney fees arising out of, directly or indirectly, any claim of personal injury or death associated with such unintended or unauthorized use, even if such claim alleges that **onsemi** was negligent regarding the design or manufacture of the part. **onsemi** is an Equal Opportunity/Affirmative Action Employer. This literature is subject to all applicable copyright laws and is not for resale in any manner.

PUBLICATION ORDERING INFORMATION

LITERATURE FULFILLMENT:

Email Requests to: orderlit@onsemi.com

onsemi Website: www.onsemi.com

TECHNICAL SUPPORT

North American Technical Support:

Voice Mail: 1 800-282-9855 Toll Free USA/Canada

Phone: 011 421 33 790 2910

Europe, Middle East and Africa Technical Support:

Phone: 00421 33 790 2910

For additional information, please contact your local Sales Representative

Mouser Electronics

Authorized Distributor

Click to View Pricing, Inventory, Delivery & Lifecycle Information:

[onsemi:](#)

[2N7002_D87Z](#) [2N7000BU](#) [2N7000TA](#) [2N7000_D75Z](#) [2N7002MTF](#) [2N7000_D74Z](#) [2N7000_D26Z](#) [2N7000_J61Z](#)
[NDS7002A_D87Z](#) [2N7002_S00Z](#) [NDS7002A_NB9GGTXA](#) [2N7002_NB9G002](#) [2N7002_L99Z](#) [2N7002_Q](#) [2N7000_Q](#)
[NDS7002A_Q](#) [2N7000_D26Z_Q](#) [2N7002-D87Z](#)