

Advanced Process Technology
Dynamic dv/dt Rating
175 Operating Temperature
Fast Switching
Fully Avalanche Rated

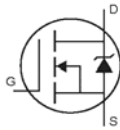

$V_{DSS}=55V$
 $R_{DS(on)}=0.07\Omega$
 $I_D=17A$

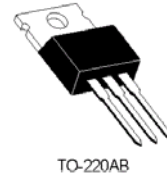

Description

Fifth Generation HEXFET ® power MOSFETs from International Rectifier utilize advanced processing techniques to achieve the lowest possible on-resistance per silicon area. This benefit, combined with the fast switching speed and ruggedized device that HEXFET power MOSFETs are well known for, provides the designer with an extremely efficient device for use in a wide variety of applications.

The TO-220 package is universally preferred for all commercial-industrial applications at power dissipation levels to approximately 50 watts. The low thermal resistance and low package cost of the TO-220 contribute to its wide acceptance throughout the industry.

Absolute Maximum Ratings

	Parameter	Max.	Units
$I_D @ T_C=25$	Continuous Drain Current, VGS @ 10V	17	A
$I_D @ T_C=100$	Continuous Drain Current, VGS @ 10V	12	
I_{DM}	Pulsed Drain Current	68	
$P_D @ T_C=25$	Power Dissipation	45	W
	Linear Derating Factor	0.30	W/
V_{GS}	Gate-to-Source Voltage	± 20	V
E_{AS}	Single Pulse Avalanche Energy	71	mJ
I_{AR}	Avalanche Current	10	A
E_{AR}	Repetitive Avalanche Energy	4.5	mJ
dv/dt	Peak Diode Recovery dv/dt	5.0	V/ns
T_J I_{STG}	Operating Junction and Storage Temperature Range	-55 to +175	
	Soldering Temperature, for 10 seconds	300 (1.6mm from case)	
	Mounting torque, 6-32 or M3 screw.	10 lbf•in (1.1N•m)	

Thermal Resistance

	Parameter	Min.	Typ.	Max.	Units
$R_{\theta JC}$	Junction-to-Case	-	-	3.3	/W
$R_{\theta CS}$	Case-to-Sink, Flat, Greased Surface	-	0.50	-	
$R_{\theta JC}$	Junction-to-Ambient	-	-	62	

Electrical Characteristics @ $T_J=25$ (unless otherwise specified)

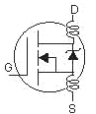
	Parameter	Min.	Typ.	Max.	Units	Conditions
$V_{(BR)DSS}$	Drain-to-Source Breakdown Voltage	55	-	-	V	$V_{GS}=0V, I_D=250\mu A$
$\Delta V_{(BR)DSS}/\Delta T_J$	Breakdown Voltage Temp. Coefficient	-	0.052	-	V/	Reference to 25 , $I_D=1mA$
$R_{DS(on)}$	Static Drain-to-Source On-Resistance	-	-	0.07	Ω	$V_{GS}=10V, I_D=10A$
$V_{GS(th)}$	Gate Threshold Voltage	2.0	-	4.0	V	$V_{DS}=V_{GS}, I_D=250\mu A$
gfs	Forward Transconductance	4.5	-	-	S	$V_{DS}=25V, I_D=10A$
I_{DSS}	Drain-to-Source Leakage Current	-	-	25	μA	$V_{DS}=55V, V_{GS}=0V$
		-	-	250		$V_{DS}=44V, V_{GS}=0V, T_J=150$
I_{GSS}	Gate-to-Source Forward Leakage	-	-	100	nA	$V_{GS}=20V$
	Gate-to-Source Reverse Leakage	-	-	-100		$V_{GS}=-20V$
Qg	Total Gate Charge	-	-	20	nC	$I_D=10A$
Qgs	Gate-to-Source Charge	-	-	5.3		$V_{DS}=44V$
Qgd	Gate-to-Drain ("Miller") Charge	-	-	7.6		$V_{GS}=10V$, See Fig. 6 and 13
td(on)	Turn-On Delay Time	-	4.9	-	ns	$I_D=10A$
tr	Rise Time	-	34	-		$I_D=10A$
td(off)	Turn-Off Delay Time	-	19	-		$R_G=24\Omega$
tf	Fall Time	-	27	-		$R_D=2.6\Omega$, See Fig.10
L_D	Internal Drain Inductance	-	4.5	-	nH	Between lead,  6mm (0.25in.) from package and center of die contact
L_S	Internal Source Inductance	-	7.5	-		
C_{iss}	Input Capacitance	-	370	-	pF	$V_{GS}=0V$
C_{DSS}	Output Capacitance	-	140	-		$V_{DS}=25V$
C_{rSS}	Reverse Transfer Capacitance	-	65	-		$F=1.0MHz$, See Fig.5

Source-Drain Ratings and Characteristics

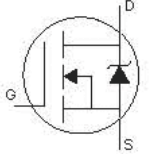
	Parameter	Min.	Typ.	Max.	Units	Conditions
I_S	Continuous Source Current (Body Diode)	-	-	17	A	MOSFET symbol showing the integral reverse p-n junction diode. 
I_{SM}	Pulsed Source Current (Body Diode)	-	-	68		
V_{SD}	Diode Forward Voltage	-	-	1.3	V	$T_J=25$, $I_S=10A, V_{GS}=0V$
trr	Reverse Recovery Time	-	56	83	ns	$T_J=25$, $I_F=10A$
Qrr	Reverse Recovery Charge	-	120	180	nC	$di/dt=100A/\mu s$

Notes:

Repetitive rating; pulse width limited by max. junction temperature. (See fig.11)

 $V_{DD}=25V$, starting $T_J=25$, $L=1.0mH, R_G=25\Omega, I_{AS}=10A$. (See Figure 12)

 $I_{SD}\leq 10A, di/dt \leq 280A/\mu s, V_{DD}\leq V_{(BR)DSS}, T_J\leq 175$

 Pulse width $\leq 300\mu s$; duty cycle $\leq 2\%$.

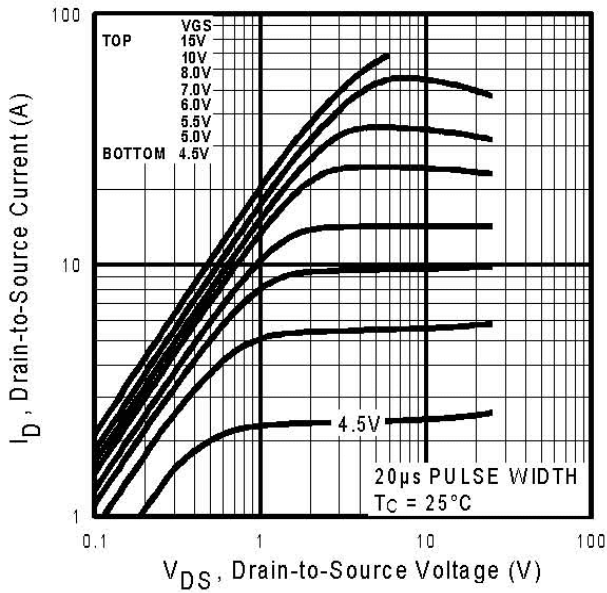

Fig 1. Typical Output Characteristics,
 $T_J=25$

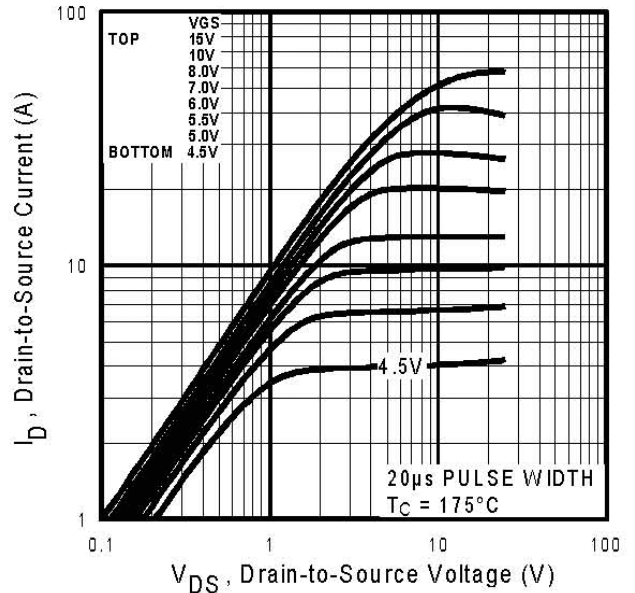

Fig 2. Typical Output Characteristics,
 $T_J=175$

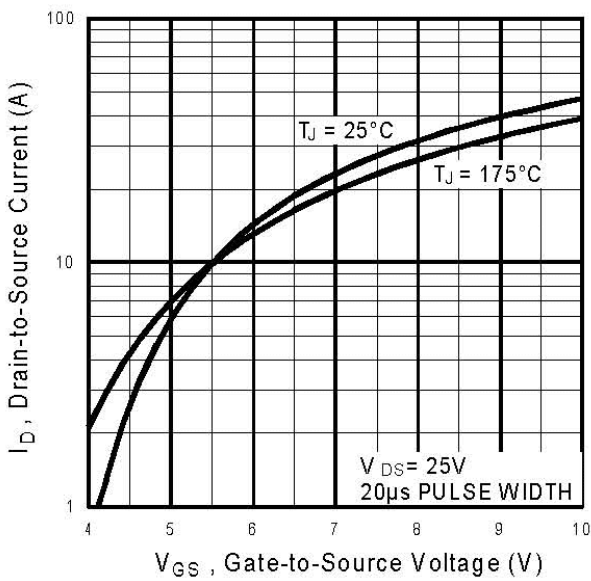

Fig 3. Typical Transfer Characteristics

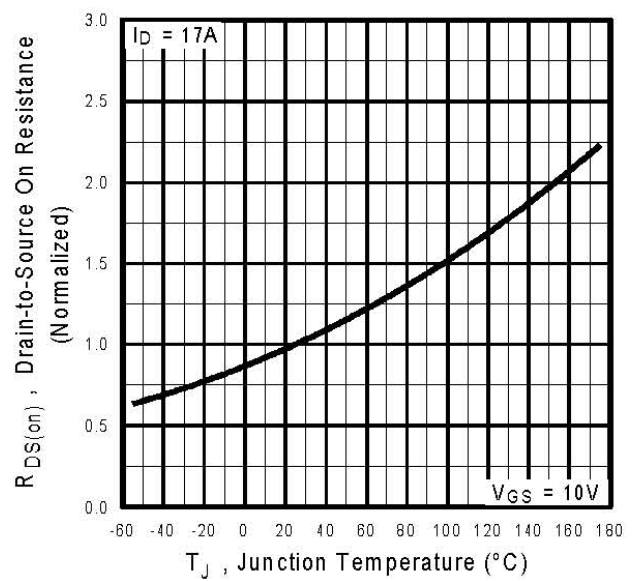

Fig 4. Normalized On-Resistance
Vs. Temperature

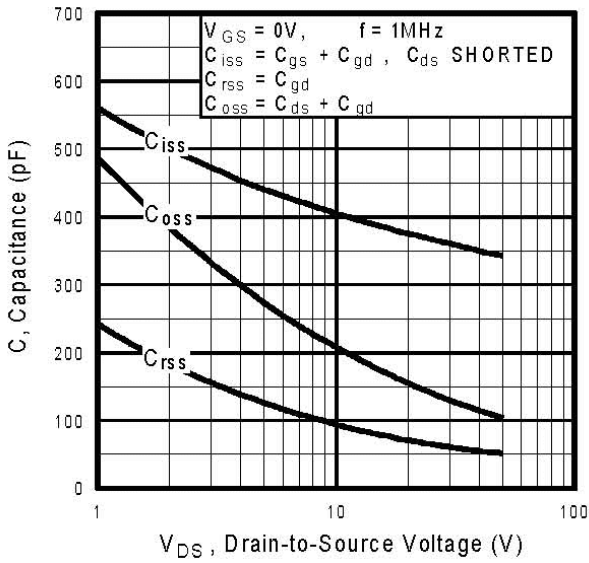

Fig 5. Typical Capacitance Vs. Drain-to-Source Voltage

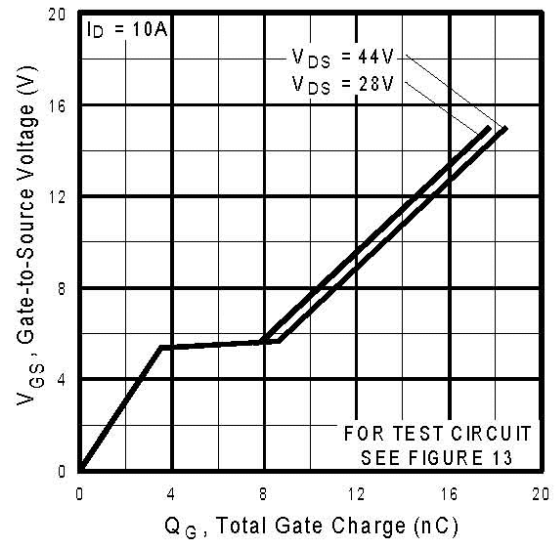

Fig 6. Typical Gate Charge Vs. Gate-to-Source Voltage

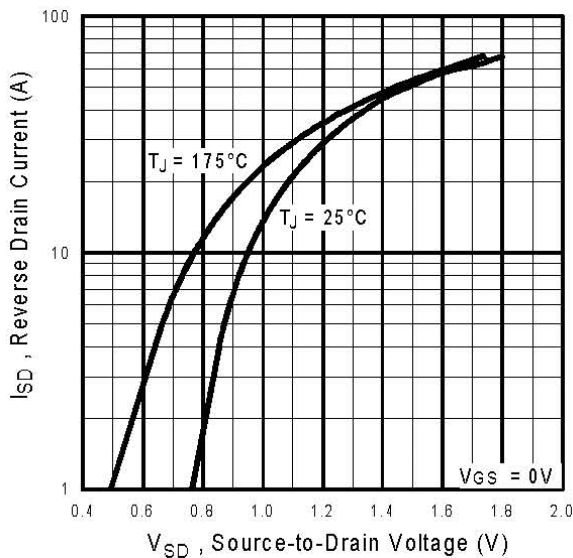

Fig 7. Typical Source-Drain Diode Forward Voltage

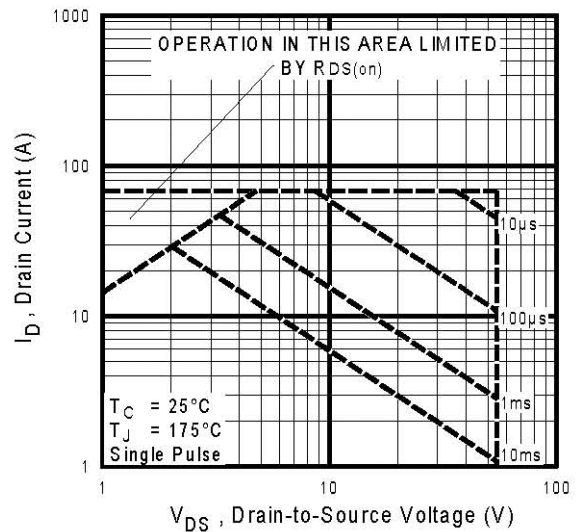

Fig 8. Maximum Safe Operating Area

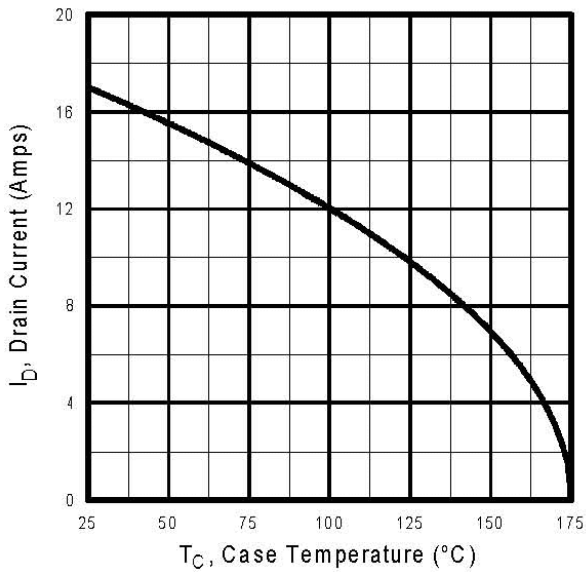

Fig 9. Maximum Drain Current Vs. Case Temperature

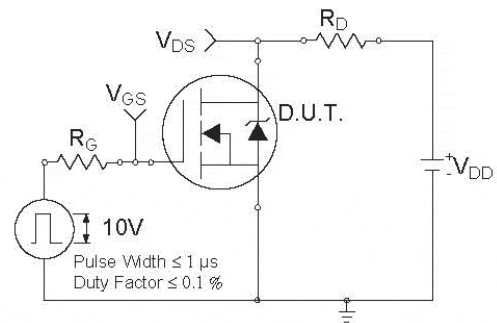

Fig 10a. Switching Time Test Circuit

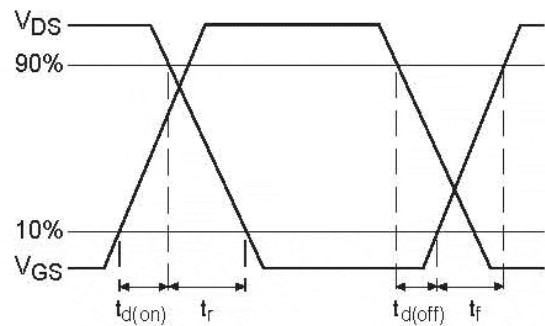

Fig 10b. Switching Time Waveforms

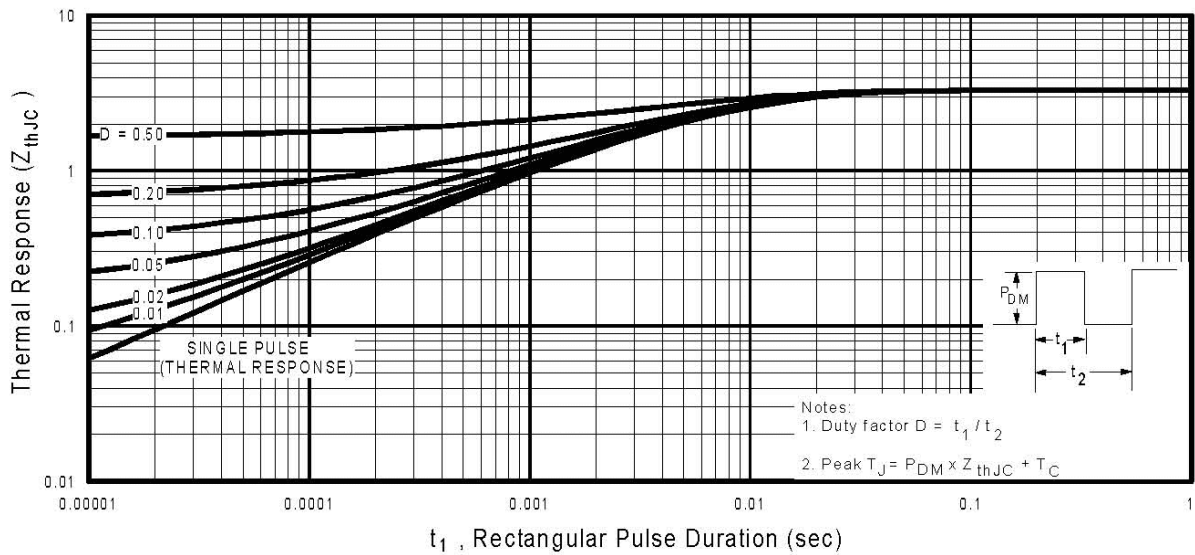

Fig 11. Maximum Effective Transient Thermal Impedance, Junction-to-Case

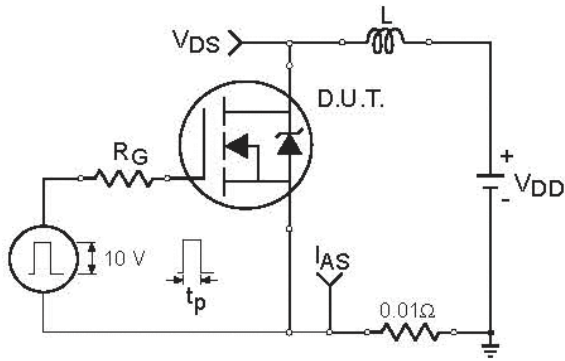

Fig 12a. Unclamped Inductive Test Circuit

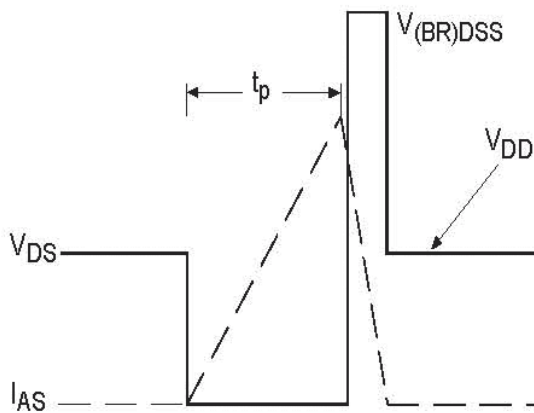

Fig 12b. Unclamped Inductive Waveforms

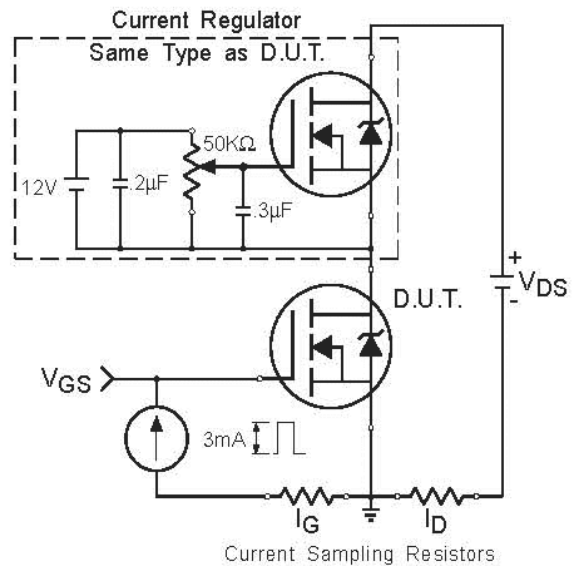
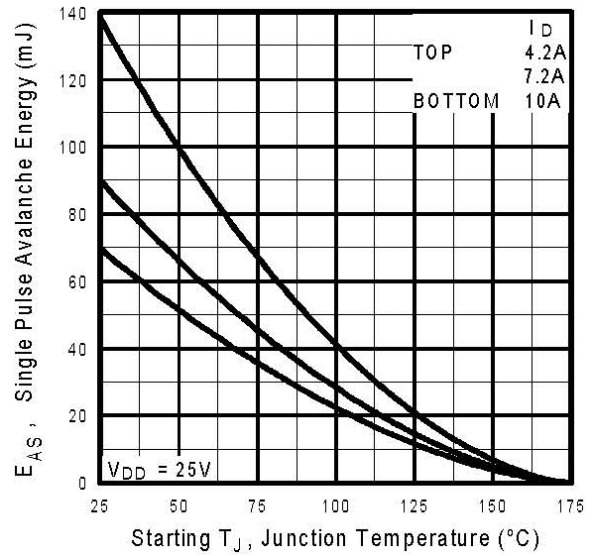
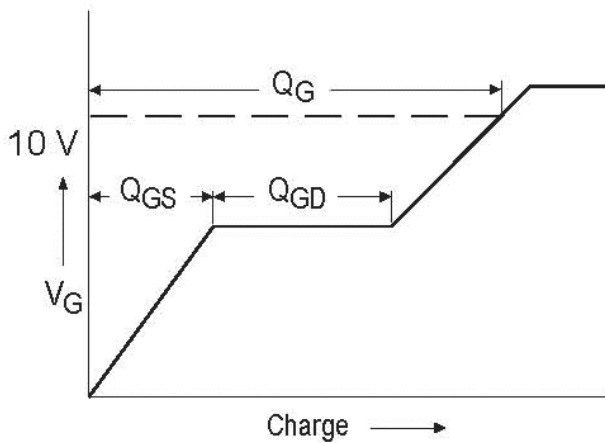
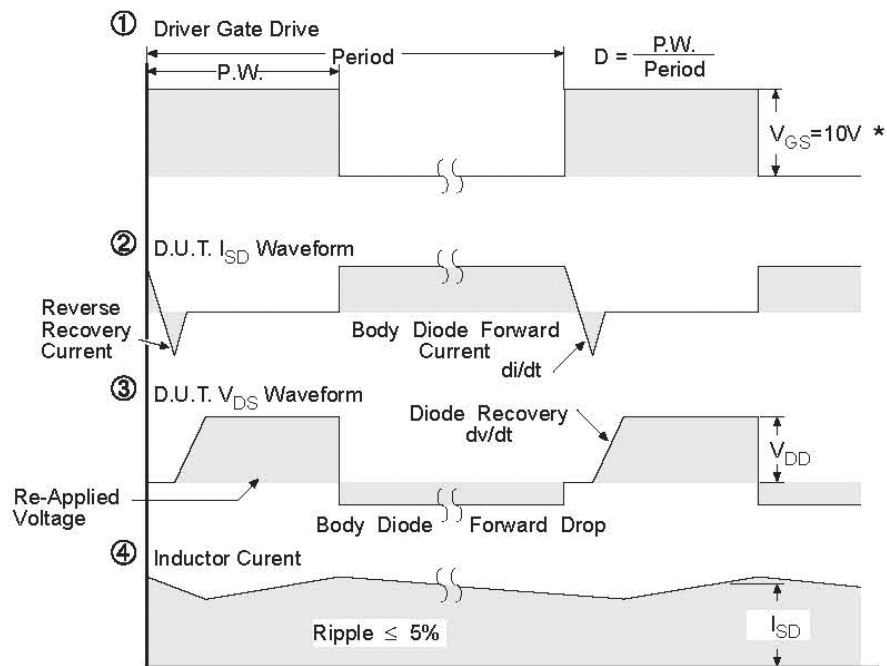
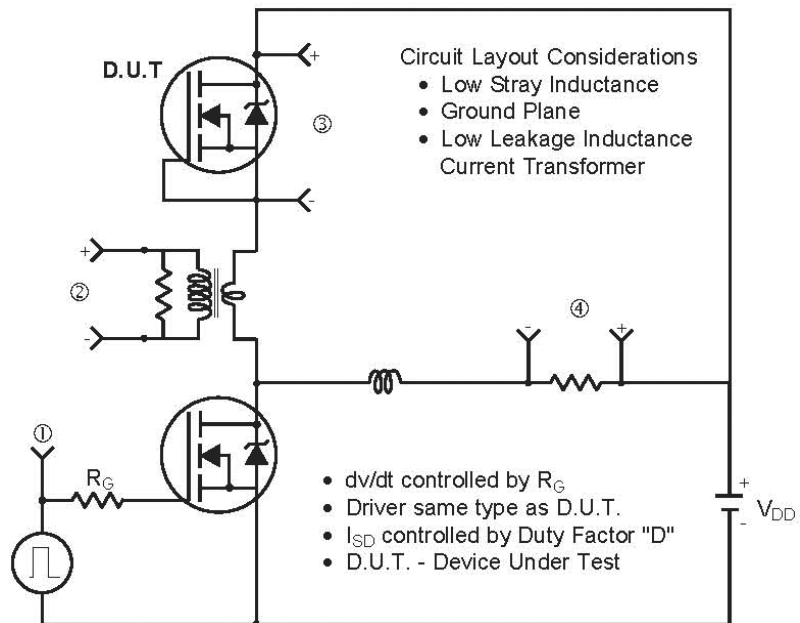

Fig 13b. Gate Charge Test Circuit

Peak Diode Recovery dv/dt Test Circuit



* $V_{GS} = 5V$ for Logic Level Devices

Fig 14. For N-Channel HEXFET ® power MOSFETs

Package Outline

TO-220AB

Dimensions are shown in millimeters (inches)

